

Canon

PUB. DIM-0946-000

VIXIA
HFR10

VIXIA
HFR11

VIXIA
HFR100

NTSC



English

Français

Español

PictBridge

HDMI

AVCHD

Important Usage Instructions

WARNING!

TO REDUCE THE RISK OF FIRE OR ELECTRIC SHOCK, DO NOT EXPOSE THIS PRODUCT TO RAIN OR MOISTURE.

WARNING!

TO REDUCE THE RISK OF ELECTRIC SHOCK AND TO REDUCE ANNOYING INTERFERENCE, USE THE RECOMMENDED ACCESSORIES ONLY.

COPYRIGHT WARNING:

Unauthorized recording of copyrighted materials may infringe on the rights of copyright owners and be contrary to copyright laws.

HD Camcorder, VIXIA HF R11 A / VIXIA HF R10 A / VIXIA HF R100 A systems

This device complies with Part 15 of the FCC Rules. Operation is subject to the following two conditions: (1) This device may not cause harmful interference, and (2) this device must accept any interference received, including interference that may cause undesired operation.

Note: This equipment has been tested and found to comply with the limits for class B digital device, pursuant to Part 15 of the FCC Rules. These limits are designed to provide reasonable protection against harmful interference in a residential installation. This equipment generates, uses and can radiate radio frequency energy and, if not installed and use in accordance with the instructions, may cause harmful interference to radio communications. However, there is no guarantee that interference will not occur in a particular installation. If this equipment does cause harmful interference to radio or television reception, which can be determined by turning the equipment off and on, the user is encouraged to try to correct the interference by one or more of the following measures:

- Reorient or relocate the receiving antenna.
- Increase the separation between the equipment and receiver.
- Connect the equipment into an outlet on a circuit different from that to which the receiver is connected.
- Consult the dealer or an experienced radio/TV technician for help.

Use of shielded cable is required to comply with class B limits in Subpart B of Part 15 of FCC Rules. Do not make any changes or modifications to the equipment unless otherwise specified in the manual.

If such changes or modifications should be made, you could be required to stop operation of the equipment.

Canon U.S.A., Inc.
One Canon Plaza, Lake Success, NY 11042, U.S.A.
Tel No. (516)328-5600

CAUTION:

TO PREVENT ELECTRIC SHOCK, MATCH WIDE BLADE OF PLUG TO WIDE SLOT, FULLY INSERT.

WARNING:

To reduce the risk of electric shock, do not expose this product to dripping or splashing.

The Mains plug is used as the disconnect device. The Mains plug shall remain readily operable to disconnect the plug in case of an accident.

CAUTION:

- Danger of explosion if the wrong type of batteries are attached. Use only the same type of batteries.
- Do not expose batteries or product to excessive heat such as the inside of a car under direct sunlight, fire, etc.

Important Warning**CAUTION:**

TO REDUCE THE RISK OF ELECTRIC SHOCK, DO NOT REMOVE COVER (OR BACK). NO USER-SERVICEABLE PARTS INSIDE. REFER SERVICING TO QUALIFIED SERVICE PERSONNEL.



The lightning flash with arrowhead symbol, within an equilateral triangle, is intended to alert the user to the presence of uninsulated "dangerous voltage" within the product's enclosure, that may be of sufficient magnitude to constitute a risk of electric shock to persons.



The exclamation point, within an equilateral triangle, is intended to alert the user to the presence of important operating and maintenance (servicing) instructions in the literature accompanying the product.

IMPORTANT SAFETY INSTRUCTIONS

In these safety instructions the word “apparatus” or “product” refers to the Canon HD Camcorder VIXIA HF R11 A / VIXIA HF R10 A / VIXIA HF R100 A and all its accessories.

- 1 Read these instructions.
- 2 Keep these instructions.
- 3 Heed all warnings.
- 4 Follow all instructions.
- 5 Do not use this apparatus near water.
- 6 Clean only with dry cloth.
- 7 Do not install near any heat sources such as radiators, heat registers, stoves, or other apparatus (including amplifiers) that produce heat.
- 8 Protect the power cord from being walked on or pinched particularly at plugs, convenience receptacles, and the point where they exit from the apparatus.
- 9 Unplug this apparatus during lightning storms or when unused for long periods of time.
- 10 Read instructions — All the safety and operating instructions should be read before the product is operated.
- 11 Retain instructions — The safety and operating instructions should be retained for future reference.
- 12 Heed Warnings — All warnings on the product and in the operating instructions should be adhered to.
- 13 Follow instructions — All operating and maintenance instructions should be followed.
- 14 Cleaning — Unplug this product from the wall outlet before cleaning. Do not use liquid or aerosol cleaners. The product should be cleaned only as recommended in this manual.
- 15 Avoid magnetic or electric fields — Do not use the camera close to TV transmitters, portable communication devices or other sources of electric or magnetic radiation. They may cause picture interference, or permanently damage the camera.
- 16 Water and Moisture — Hazard of electric shock — Do not use this product near water or in rainy/moist situations.
- 17 Placing or Moving — Do not place on an unstable cart, stand, tripod, bracket or table. The product may fall, causing serious injury to a child or adult, and serious damage to the product. A product and cart combination should be moved with care. Quick stops, excessive force, and uneven surfaces may cause the product and cart combination to overturn.
- 18 Power Sources — The product should be operated only from the type of power source indicated on the marking label. If you are not sure of the type of power supply to your home, consult your product dealer or local power company. Regarding other power sources such as battery power, refer to instructions in this manual.
- 19 Overloading — Do not overload wall outlets and extension cords as this can result in a risk of fire or electric shock.

- 20 **Objects and Liquid Entry** — Never push objects of any kind into this product through openings as they may touch dangerous voltage points or short out parts that could result in a fire or electric shock. Be careful not to spill liquid of any kind onto the product.
- 21 **Servicing** — Do not attempt to service this product yourself as opening or removing covers may expose you to dangerous voltage or other hazards. Refer all servicing to qualified service personnel.
- 22 **Power Sources** — The CA-590 Compact Power Adapter should be operated only from the type of power source indicated on the marking label. If you are not sure of the type of power supply to your home, consult your product dealer or local power company. Regarding other power sources such as battery power, refer to instructions in this manual.
- 23 **Lightning** — For added protection of this product during a lightning storm, or when it is left unattended and unused for long periods of time, disconnect it from the wall outlet and disconnect the antenna. This will prevent damage to the product due to lightning and power-line surges.
- 24 **Overloading** — Do not overload wall outlets and extension cords as this can result in a risk of fire or electric shock.
- 25 **Damage Requiring Service** — Disconnect this product from the wall outlet and all power sources including battery, and refer servicing to qualified service personnel under the following conditions:
 - a. When the plug is damaged.
 - b. If any liquid has been spilled onto, or objects have fallen into, the product.
 - c. If the product has been exposed to rain or water.
 - d. If the product does not operate normally even if you follow the operating instructions. Adjust only those controls that are covered by the operation instructions. Improper adjustment of other controls may result in damage and will often require extensive work by a qualified technician to restore the product to its normal operation.
 - e. If the product has been dropped or the cabinet has been damaged.
 - f. When the product exhibits a distinct change in performance. This indicates a need for service.
- 26 **Replacement Parts** — When replacement parts are required, be sure the service technician has used replacement parts that are specified by Canon or that have the same characteristics as the original part. Unauthorized substitutions may result in fire, electric shock or other hazards.
- 27 **Safety Check** — Upon completion of any service or repairs to this product, ask the service technician to perform safety checks to determine that the product is in safe operating order.

This product is not intended to be serviced. Should the product cease to function in its intended manner, it should be returned to the manufacturer or be discarded.

When replacement of the power supply is required, please return it to the responsible nearest Canon Service Center and please replace it with the same type number CA-590.

This Class B digital apparatus complies with Canadian ICES-003.

The adapter can be used with a power supply between 100 and 240 V AC. For areas where 120 V AC power is not used, you will need a special plug adapter. Contact your nearest Canon Service Center for further information.

The adapter is not intended to be serviced. Should the product cease to function in its intended manner, it should be returned to the manufacturer or be discarded.

The serial number of this product can be found on the battery compartment cover of the camcorder. Write down the number and other information here and retain this book as a permanent record of your purchase to aid identification in case of theft.

Model Name: VIXIA HF R11 A / VIXIA HF R10 A / VIXIA HF R100 A

Date of Purchase:

Serial No.:

Purchased From:

Dealer Address:

Dealer Phone No.:

Trademark Acknowledgements

- The SD logo is a trademark. The SDHC logo is a trademark.
- Microsoft and Windows are trademarks or registered trademarks of Microsoft Corporation in the United States and/or other countries.
- Macintosh and Mac OS are trademarks of Apple Inc., registered in the U.S. and other countries.
- “x.v.Color” and the x.v.Colour logo are trademarks.
- HDMI, the HDMI logo and High-Definition Multimedia Interface are trademarks or registered trademarks of HDMI Licensing LLC.
- “AVCHD” and the “AVCHD” logo are trademarks of Panasonic Corporation and Sony Corporation.
- Manufactured under license from Dolby Laboratories.
“Dolby” and the double-D symbol are trademarks of Dolby Laboratories.
- YouTube is a trademark of Google Inc.
- Other names and products not mentioned above may be trademarks or registered trademarks of their respective companies.
- This device incorporates exFAT technology licensed from Microsoft.
- ANY USE OF THIS PRODUCT OTHER THAN CONSUMER PERSONAL USE IN ANY MANNER THAT COMPLIES WITH THE MPEG-2 STANDARD FOR ENCODING VIDEO INFORMATION FOR PACKAGED MEDIA IS EXPRESSLY PROHIBITED WITHOUT A LICENSE UNDER APPLICABLE PATENTS IN THE MPEG-2 PATENT PORTFOLIO, WHICH LICENSE IS AVAILABLE FROM MPEG LA, L.L.C., 250 STEELE STREET, SUITE 300, DENVER, COLORADO 80206.
- This product is licensed under AT&T patents for the MPEG-4 standard and may be used for encoding MPEG-4 compliant video and/or decoding MPEG-4 compliant video that was encoded only (1) for a personal and non-commercial purpose or (2) by a video provider licensed under the AT&T patents to provide MPEG-4 compliant video. No license is granted or implied for any other use for MPEG-4 standard.



Package contents

- CA-590 Compact Power Adapter* [①]
- BP-2L5 Battery Pack
- STV-250N Stereo Video Cable (yellow, red, white plugs) [②]
- CTC-100/S Component Cable (red, green, blue plugs) [③]
- IFC-300PCU USB Cable [④]
- 3 Software CD-ROMs
 - **PIXELA Application - Disc 1** and Disc 2**
'PIXELA Applications' Installation Guide also included.
 -  **Instruction Manual/Photo Applications Ver.34.0*/Music Data**
CD-ROM
Contains the full-version Instruction Manual of the camcorder (PDF file).
See the explanation on the next page.

* CA-590E including power cord, in Asia.

**The CD-ROM includes the instruction manual of the software (PDF file).

See *Supplied Accessories and CD-ROMs* ( PDF 16) for details about the supplied software applications and their uses.

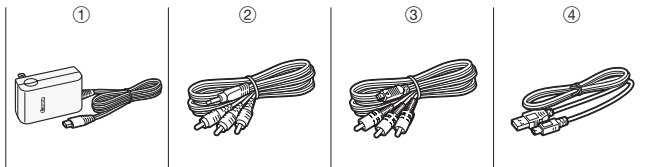



About the Camcorder's PDF Instruction Manual

This guide will get you started and show you how to use the most basic functions of your camcorder to shoot video, take photos and play back your recordings (using the camcorder or connecting it to your TV). To learn more about the more advanced functions of your camcorder, to read important handling precautions and to consult the troubleshooting section if an error message is displayed, be sure to read the full instruction manual, included as a PDF* file in the  **Instruction Manual/Photo Applications Ver.34.0/ Music Data** CD-ROM.



- 1 Turn on the computer.
- 2 Insert the  **Instruction Manual/Photo Applications Ver.34.0*/Music Data** CD-ROM into the computer's disc drive.
- 3 Open [My Computer].
Windows Vista/Windows 7 users: Open [Computer] instead.
- 4 Right-click the drive into which you inserted the CD-ROM and select [Open].
- 5 Open the [MANUALS_ENGLISH] folder.
The folder contains the instruction manual of the camcorder and that of the supplied software Photo Application. For easy access later, you can copy the PDF files to your computer's desktop.

***Adobe® Reader®** 6 or later is required to view the PDF Instruction Manual.



Table of Contents

08	Package Contents
11	Names of Parts and Icons
18	Charging the Battery Pack
22	Operating Modes of the Camcorder
26	Getting Ready to Start Recording
29	Basic Recording: Shooting Video and Taking Photos
37	Basic Playback: Playing Back Movies and Viewing Photos
41	Saving and Sharing Your Recordings
42	Playback on a TV Screen
45	Abridged Specifications

Conventions Used in the Quick Guide

-  **IMPORTANT:** Precautions related to the camcorder's operation.
-  **NOTES:** Additional topics that complement the basic operating procedures.
-  Reference page number in this Quick Guide.

 **PDF** : Reference page number in the camcorder's full version Instruction Manual (PDF file).

- **HFRT11**: Text that applies only to the model(s) shown in the icon.
- Brackets [] are used to refer to menu options as they are displayed on screen.
- The names of most buttons and switches are indicated within a "button" frame.
- The  arrow is used to abbreviate menu selections. For a detailed explanation refer to *Using the Menus* ( **PDF** 31).
- The photos included in this manual are simulated pictures taken with a still camera. Unless indicated otherwise, illustrations and menu icons refer to the **HFRT11**.

Names of Parts and Icons

Left side view

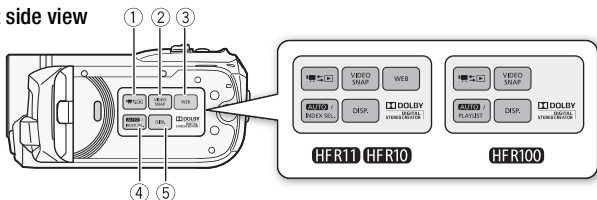

Right side view

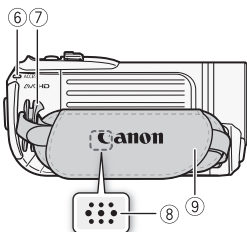

- ① (camera/play) button (22)
- ② **VIDEO SNAP (video snapshot) button:** Shoot short videos (a few seconds in length) and arrange them into a video clip set to your favorite background music. (PDF > 58)
- ③ **HFR11 / HFR10 WEB button:** Convert your HD movies to standard-definition videos ready to be easily shared on YouTube. (PDF > 124)
- ④ **AUTO button:** Activate Smart AUTO mode to let the camcorder select the best settings for your subject. (PDF > 27)/ **HFR11 / HFR10 INDEX SEL. button:** Press to switch to the playlist or other content. (PDF > 47)/ **HFR100 PLAYLIST button:** Press to switch to the playlist. (PDF > 47)
- ⑤ **DISP. (on-screen display) button:** Display a scene's timeline screen (PDF > 71) and change the camcorder's onscreen displays. (PDF > 67)
- ⑥ **ACCESS (memory access) indicator** (PDF > 40, 86)
- ⑦ **Strap mount:** Attach an optional wrist or shoulder strap for convenience and portability. (PDF > 24)
- ⑧ **Speaker** (PDF > 45)
- ⑨ **Grip belt:** Adjust for a comfortable and secure grip. (PDF > 24)

Front view

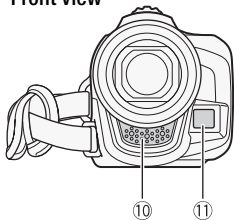

- ⑩ Stereo microphone
- ⑪ Instant AF sensor (PDF 133)
- ⑫ Zoom lever (30)
- ⑬ PHOTO button (29)
- ⑭ POWER button
- ⑮ ON/OFF (CHG) (charge) indicator:
 - Green – ON
 - Orange – Standby (33)
 - Red – Charging (18)

Top view

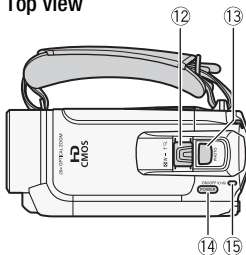

- ⑯ LCD screen (28)
- ⑰ Joystick (23)
- ⑱ **FUNC. button:** Press to access the FUNC. menu and setup menus. (When recording, the menus are accessible only in flexible recording mode.) (PDF 31, 130)

LCD panel

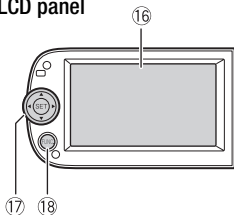

Back view

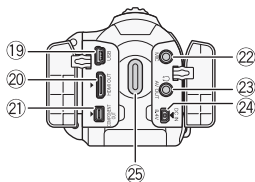

Bottom view

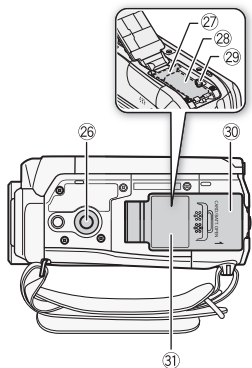

- 19 **USB terminal:** Connect the camcorder to a computer or printer. (📄PDF) 106, 109)
- 20 **HDMI OUT terminal:** Connect the camcorder to an HDTV with an HDMI™ input for the best all-digital quality. (📄 42)
- 21 **COMPONENT OUT terminal:** Connect the camcorder to an HDTV with component video inputs. (📄 42)
- 22 **MIC terminal:** Connect an external microphone. (📄PDF) 70)
- 23 **AV OUT terminal:** Connect the camcorder to a standard definition TV (📄 42)/
🔊(headphones) terminal (📄PDF) 69)
- 24 DC IN terminal (📄 18)
- 25 **START/STOP button** (📄 29)
- 26 **Tripod socket:** Mount the camcorder on a tripod for steadier shots. (📄PDF) 163)
- 27 Memory card slot (📄 26)
- 28 Battery compartment
- 29 Battery release latch
- 30 Battery compartment cover/Memory card slot cover
- 31 **Serial number**

The serial number label is located on the battery compartment cover.

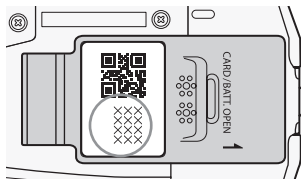

Onscreen Displays and Icons

Recording movies

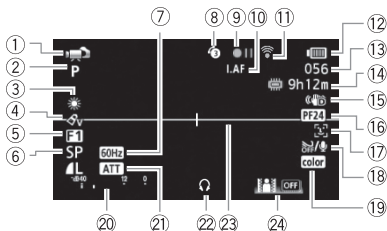

- ① Operating mode (📖 22)
- ② **Recording program:** Recording programs allow you to change various picture-related settings to your preference, or to use a Special Scene recording program to apply the camcorder settings most appropriate for a variety of situations. (📖 PDF 55, 57)
- ③ **White balance:** Change the setting so different lighting conditions do not affect the colors in your recordings and white objects look truly white. (📖 PDF 63)
- ④ **Image effect:** Try using various image effects to change the look of your recordings. (📖 PDF 65)
- ⑤ **Digital effect:** The camcorder offers various transition effects (faders) for movies and digital effects to add some flavor to your recordings. (📖 PDF 65)
- ⑥ Recording mode (📖 35)
- ⑦ Flicker reduction (📖 PDF 133)
- ⑧ **Pre-recording:** The camcorder will start recording video 3 seconds before you press **START/STOP**, so you do not miss important shooting opportunities. (📖 PDF 59)
- ⑨ Memory operation (📖 PDF 146)
- ⑩ **I.A.F.** Instant AF (📖 PDF 133); MF Manual focus (📖 PDF 61)
- ⑪ **Eye-Fi wireless communication:** Using an Eye-Fi card, you can upload your recordings wirelessly. Important restrictions apply so be sure to refer to *Using an Eye-Fi card* (📖 PDF 128).

12 Remaining battery time

-  in red: Battery pack is almost empty. Replace with a fully charged battery pack.

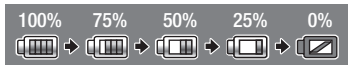

13 While recording/during playback: Scene counter (hours : minutes : seconds)

In record pause mode: Total number of scenes

14 Remaining recording time

-  On the memory card; **HFR11/HFR10**  In the built-in memory
- When there is no more free space on the memory,  End (built-in memory, **HFR11/HFR10**) or  End (memory card) will be displayed and the recording will stop.

15 Image stabilizer: The stabilizer will compensate for varying degrees of camcorder shake so you can get beautiful, steady recordings.

( PDF) 133)

16 24F progressive frame rate: Select the 24F progressive frame rate to give your recordings a cinematic look.

( PDF) 57)

17 Face detection: You can have the camcorder automatically detect people's faces and use this information to adjust the focus and set the best exposure and color control settings for beautiful videos and photos.

( PDF) 62)

18 Wind screen off: Wind screen removes the background sound of wind when recording outdoors. You may want to turn it off when recording indoors in very quiet surroundings.

( PDF) 135)

19 x.v.Color: The camcorder uses a color space with an extended gamut to achieve deeper colors, closer to real life.

( PDF) 133)

20 Audio level indicator: Manually adjust the audio recording level.

( PDF) 68)

21 Microphone attenuator: Use the attenuator to avoid audio distortions when the sound is too loud.

( PDF) 135)

22 Headphone output

( PDF) 69)

23 Level marker: Display onscreen markers to check your composition and make sure horizontal or vertical lines do not appear crooked in your recordings.

( PDF) 135)

24 Joystick guide

( PDF) 30)

Recording photos

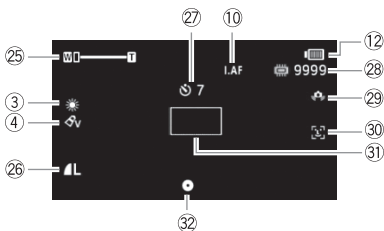

25 Zoom (☐ 29), Exposure ●—|—○ (📄PDF) 60)

26 Photo quality/size (☐ 36)

27 Self timer (📄PDF) 59)

28 Number of available photos

☐ On the memory card; **HFR11/HFR10** ☐ In the built-in memory

- ☐ in red: Cannot record any more photos.

- ☐ in red: No memory card in the camcorder.

29 **Camcorder shake warning:** When this icon appears on-screen, you may need to stabilize the camcorder using a tripod.

30 Face detection (📄PDF) 62)

31 AF frame: (📄PDF) 86)

32 Focus and exposure lock (☐ 29)

Playing movies (during playback)

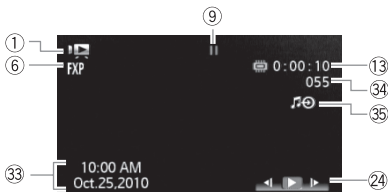

- ③③ **Data code:** In addition to the date and time of recording, you can choose to display information related to the camcorder settings like the shutter speed or aperture value used. (PDF 67)
- ③④ Scene number
- ③⑤ External audio input (PDF 75)

Viewing photos

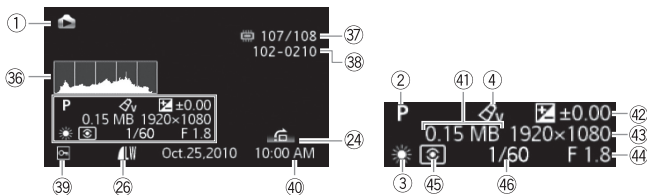

- ③⑥ **Histogram:** Gives you a graphic indication about a photo's exposure so you can confirm that it is not too dark or too bright. (PDF 95)
- ③⑦ Current photo / Total number of photos
- ③⑧ Photo number (PDF 139)
- ③⑨ **Protected photo mark:** Protect your favorite photos to prevent deleting them by mistake. (PDF 96)
- ④⑩ Date and time of recording
- ④① File size
- ④② **Manual exposure:** Correct the exposure manually for a picture darker/brighter than the one obtained using the automatic exposure set by the camcorder. (PDF 60)
- ④③ Photo size (36)
- ④④ **Aperture value:** Shows the aperture value used for the photo.
- ④⑤ Evaluative light metering*
- ④⑥ **Shutter speed:** Shows the shutter speed used for the photo.

* The light metering mode cannot be changed.

Charging the Battery Pack

The camcorder can be powered with a battery pack or directly using the compact power adapter. When you use the compact power adapter, the power of the battery pack will not be consumed. Charge the battery pack before use.

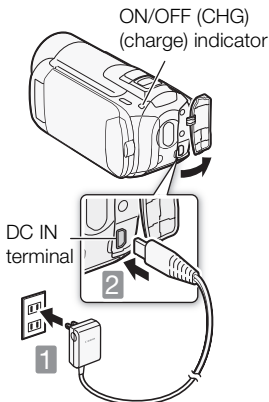

1 Connect the compact power adapter.

Plug into a power outlet.

2 Connect the camcorder.

- Plug into the DC IN terminal.
- When connecting the compact power adapter's cable to the camcorder, make sure to align the triangle marks on the cable's connector and on the camcorder's terminal (▶▶).

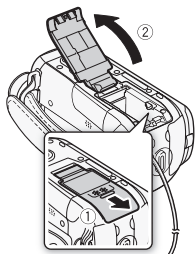
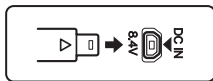

3 Insert the battery pack.

- ① Remove the battery terminal cover from the battery pack.
- ② Open the battery compartment cover.

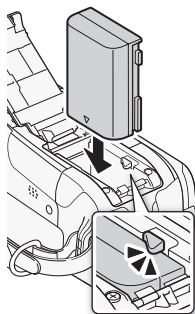

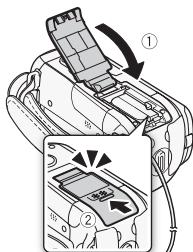

- ③ Insert softly into the compartment and press gently until it clicks.

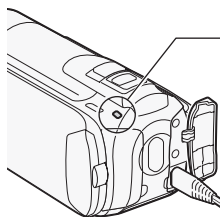

- ④ Close the battery compartment cover.

Charging will start when the camcorder is turned off.



- ON/OFF (CHG)  (POWER)
- Lamp off
(camcorder turned off)
 - Red lamp flashes
(charging)
 - Lamp off
(battery pack fully charged)



Charging times

Charging the supplied BP-2L5 Battery Pack will take approximately 2 hours 20 minutes. A fully charged battery pack will allow for the following operations (movies in FXP mode):

Typical recording		Playback
Memory card	Built-in memory*	
45 min.	45 min.	1 hr. 50 min.

* **HFR11/HFR10** only

All given times are approximate and vary according to recording mode and charging, recording or playback conditions.

See *Charging Times* ([PDF](#) 170), *Recording and Playback Times* ([PDF](#) 171) for details.

IMPORTANT

- The battery pack will be charged only when the camcorder is off.
- Turn off the camcorder before disconnecting the compact power adapter. After turning off the camcorder, important data is updated in the memory. Be sure to wait until the ON/OFF (CHG) indicator goes out.
- The first time you use a battery pack, fully charge it and then use the camcorder until the battery pack is completely exhausted.
- Do not connect to the camcorder's DC IN terminal or to the compact power adapter any electrical equipment that is not expressly recommended for use with this camcorder.
- Do not connect the supplied compact power adapter to voltage converters or special power sources such as those on aircraft, DC-AC inverters, etc.

i NOTES

- The battery pack will be charged only when the camcorder is off.
- We recommend charging the battery pack in temperatures between 10 °C and 30 °C (50 °F and 86 °F). Outside the temperature range of 0 °C to 40 °C (32 °F and 104 °F), charging will not start.
- If remaining battery time is an issue, you can power the camcorder using the compact power adapter so the battery pack will not be consumed.
- Charged battery packs continue to discharge naturally. Therefore, charge them on the day of use, or the day before, to ensure a full charge.
- We recommend that you prepare battery packs to last 2 to 3 times longer than you think you might need.
- **USA and Canada only:** The Lithium ion/polymer battery that powers the product is recyclable. Please call 1-800-8-BATTERY for information on how to recycle this battery.



Operating Modes of the Camcorder

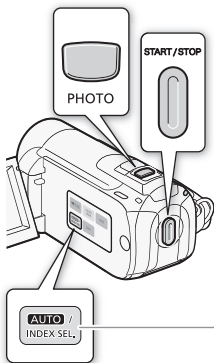





AUTO Smart AUTO

Take it easy and leave all the settings to the camcorder.

Flexible recording mode

Use the flexible recording mode to access the menus and advanced functions and to change various settings up to your preferences.

In either mode, press **START/STOP** to shoot movies or press **PHOTO** to take photos.

See *Advanced Functions* ( PDF  55),
Additional Functions ( PDF  93) for details.

Camera/Play button

Toggle between camera (recording) mode and playback mode.



- Press the button when the camcorder is off to turn it on directly in playback mode.

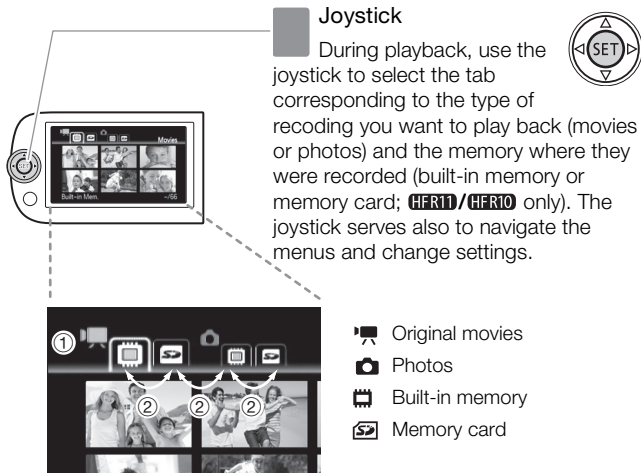

Selecting what recordings to play back

- ① Select (▲▼) the tabs at the top of the screen.
- ② Select (◀▶) the desired tab.
- ③ Return (▲▼) to the index screen to select the scene/photo you want to play back.

first time settings

Setting the Date/Time and Language

When you turn on the camcorder for the first time, you will need to set the date and time before using the camcorder. You can also change the date format and time zone. (For your convenience, you can do so after changing the language to your preference.)

See *Changing the Time Zone* ( PDF > 34) for details.



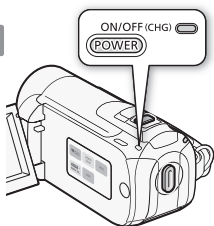

1



1 Press **POWER**.

When the internal clock is not set, the [Date/Time] screen will appear.



2 Use the joystick to change the date/time.

- ① Change () the selected field.
- ② Move () between fields.

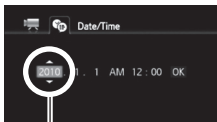
2



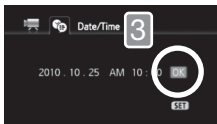

Change the year, month, and remaining fields.

3 Select () [OK] and press **SET**.



- 4** Select the language used for menus and on-screen displays. You can select one of 22 languages to display the camcorder's menus and on-screen displays. Select the language of your preference using the  menu.

See *Using the Menus* ( PDF  31) for details.

FUNC.  **[Menu]**    **[Language ** 
 Desired language  **FUNC.**

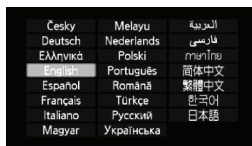
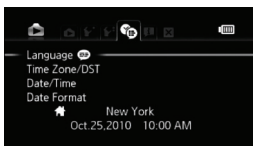



English is the default language





NOTES

- If you changed the language by mistake, look for the menu option with the  mark.

getting ready to start recording

Using a Memory Card

Use commercially available  SDHC (SD high capacity) memory cards and  SD memory cards to record movies and photos. While you can record photos on almost all types of memory cards, depending on the memory card, you may not be able to record movies.

See *Memory Cards Compatible for Use with the Camcorder* ( PDF  35) for details. Before using an Eye-Fi card, be sure to refer to *Using an Eye-Fi card* ( PDF  128).

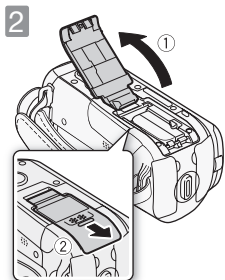

1 Turn off the camcorder.
Make sure the indicator is off.

2 Open the memory card slot cover.

3 Insert the memory card and close the memory card slot cover.

- ① Push the memory card into the memory card slot.
- ② Securely close the cover. Do not force it closed if the memory card is not correctly inserted.

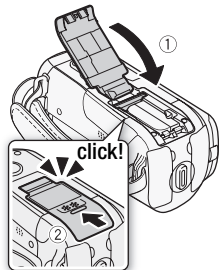
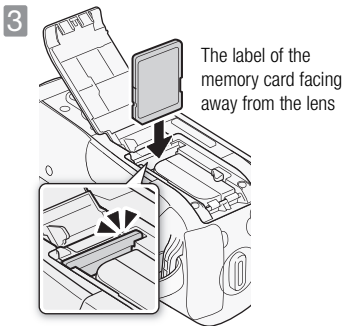

Recording in the built-in memory or on the memory card (HFRT1/HFRT0 only)

You can select to record your movies and photos in the built-in memory or on the memory card. The built-in memory is the default memory for recording both, but you can select the recording memory independently for movies and for photos.

See *Selecting the Memory for the Recordings* (PDF 37) for details. Before using an Eye-Fi card, be sure to refer to *Using an Eye-Fi card* (PDF 128).

IMPORTANT

- Memory cards have front and back sides that are not interchangeable. Inserting a memory card facing the wrong direction can cause a malfunction of the camcorder.
- Initialize memory cards when you use them with this camcorder for the first time.

See *Initializing the Built-In Memory or Memory Card* (PDF 38) for details.

NOTES

- **To remove the memory card:** Push the memory card once to release it. When the memory card springs out, pull it all the way out.

Fitting the Camcorder to You

Adjust the grip belt and other accessories beforehand for a comfortable and secure grip while using the camcorder. Familiarize yourself with the different positions of the LCD panel to find the best angle for any recording situation. You can also turn on the LCD screen's backlight or adjust its brightness.

See *Preparing the Accessories* (PDF 24), *Adjusting the Position and Brightness of the LCD screen* (PDF 25), *[LCD Brightness]* and *[LCD Screen Dimmer]* (PDF 137) for details.

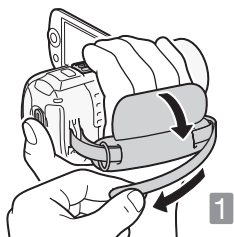

1 Fasten the grip belt.

Adjust it so you can reach the zoom lever with your index finger, and the **START/STOP** button with your thumb. You can use the grip belt together with an optional shoulder strap.

2

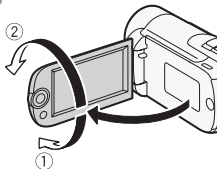

2 Open the LCD panel and adjust the angle.

- 1 Rotate it up to 90 degrees down (for example, to record with your hand extended above a crowd).
- 2 Rotate it up to 180 degrees toward the lens (for example, to record video of yourself).

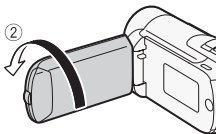

Shooting Video and Taking Photos

With Smart AUTO you can easily record movies and photos. You do not need to worry about any settings or menu options - the camcorder will select the most appropriate settings automatically.

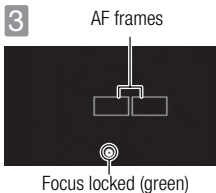
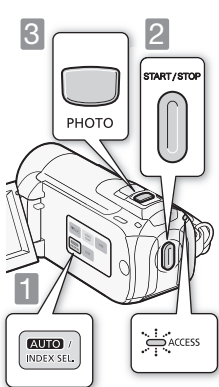

1 Set the camcorder to Smart AUTO.

- 1 Press **POWER**.
- 2 Press **AUTO**.

2 Start recording movies.

- 1 Press **START/STOP** to start recording. Press again to pause the recording and record the video on the memory as one scene.
- 2 The **ACCESS** indicator flashes in red while shooting video and while a scene or photo is being recorded on the memory.

3 Take a photo.

- 1 Press **PHOTO** halfway to activate the autofocus (AF) and lock the focus and exposure.
- 2 Then press fully to record the photo.

Use the zoom to frame the subject

Use the zoom lever to zoom out and in. To zoom out, zoom toward the **W** (wide angle) end. To zoom in, zoom toward the **T** (telephoto) end.

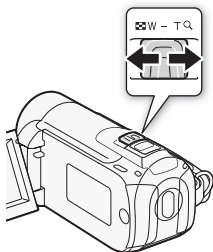

! IMPORTANT

- Observe the following precautions while the ACCESS indicator is on or flashing. Failing to do so may result in permanent data loss or damage to the memory.
 - Do not open the memory card slot cover.
 - Do not disconnect the power source or turn off the camcorder.
 - Do not change the operating mode - do not press the  button or **AUTO** button.

i NOTES

- **Smart AUTO mode:** In **AUTO** mode the camcorder will automatically use the Smart AUTO mode so you can get perfect recordings every time. Just point the camcorder and Smart AUTO will automatically select the best settings for your subject and the scene you want to use. One of 31 icons will appear depending on the characteristics of the subject, background, lighting conditions, etc.
See *About the Smart AUTO mode* ( PDF > 27) for details.

- **About the flexible recording mode:** Use the flexible recording mode to access the menus and advanced functions and to change various settings up to your preferences. Press **AUTO** again to switch back to the flexible recording mode.

See *Shooting Video* (PDF 40) and all through Advanced Functions, and *Taking Photos* (PDF 86) and all through Additional Functions for details.

- When recording photos, if the camcorder cannot focus on the subject automatically,  turns yellow.

- **About the zoom:** The camcorder features 20x optical zoom. When recording movies, you can also use the digital zoom.

See *[Digital Zoom]* (PDF 133) for details.

- **About the zoom speed:** The zoom lever is set to a variable speed. That is, the zoom speed depends on how you press the lever: press gently for slower zooms; press harder for faster zooms. You can also change the zoom speed to one of three constant speeds.

See *Zooming* (PDF 42), *[Zoom Speed]* (PDF 133) for details.

- In most situations, keep at least 1 m away from the subject. The minimum focusing distance at full wide angle is 1 cm.

When you have finished recording

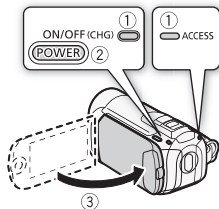

Make sure the camcorder has finished writing the scenes or photos on the memory before turning it off.

- ① Check that the indicator is off.
- ② Press **POWER** .
- ③ Close the LCD panel.

③ Confirm that the indicator goes out

Quick Start Function

While recording, instead of leaving the camcorder in record pause mode, you can simply close the LCD panel to set the camcorder in standby mode. In standby mode the camcorder consumes only about 1/3 the power used when recording, saving energy when you are using a battery pack. Additionally, when you open the LCD panel, the camcorder is ready to start recording in approximately 1 second*, allowing you to start recording right away.

* The actual time required varies depending on the shooting conditions.

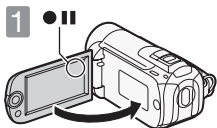

1 In record pause (● |||), close the LCD panel.

① Changes to orange to indicate the camcorder is in standby mode.

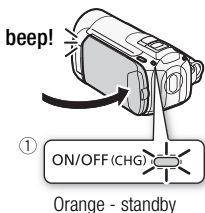

2 When you wish to resume recording, open the LCD panel.

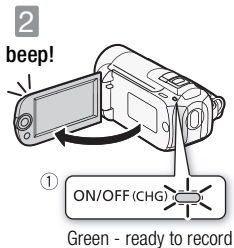

① Changes back to green.



IMPORTANT

- Do not disconnect the power source during standby mode (while the ON/OFF (CHG) indicator is lit in orange).

NOTES

- If you close the LCD panel under some circumstances (for example while the memory card slot cover is open or when the battery charge is too low), the camcorder may not enter the standby mode. Check that the indicator changes to orange.
- The camcorder will power off automatically if left in standby mode for 10 minutes. In that case, press **[POWER]** to turn on the camcorder. You can select the length of time until shut-off or turn off the Quick Start function. See *[Power Saving Mode]* ( **PDF**  138) for details.
- You can use the Quick Start function also in the flexible recording mode in the same manner.

Selecting the Quality of Video

The camcorder offers 4 recording modes (or levels of video quality). Changing the recording mode will change the recording time available on the memory. Select FXP or XP+ mode for better movie quality or LP mode for longer recording times.

See *Selecting the Video Quality (Recording Mode)* (PDF 41) for approximate recording times.

You need to access the FUNC. menu to select the recording mode, but the recording mode selected will apply also when the camcorder is set to Smart AUTO.

See *Using the Menus* (PDF 31) for details.

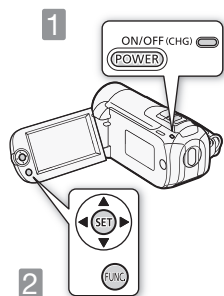

1 Press **POWER**.

2 Select the recording mode.

- ① **FUNC.** >
- ② **[SP Standard Play 7 Mbps]** >
- ③ Desired recording mode >
- ④ **FUNC.**

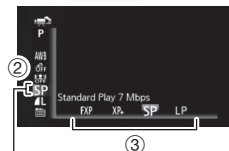

Default recording mode

Selecting the Size and Quality of Photos

The camcorder offers 3 photo sizes and 3 levels of photo quality. As a general rule, select a larger photo size for higher quality. Select the [LW 1920x1080] size for photos with an aspect ratio of 16:9.

See *Selecting Photo Size and Quality* (PDF 87) for the approximate number of photos that can be recorded on a memory card and the print size recommended for each photo size.

You need to access the FUNC. menu to select the photo size and quality, but the settings selected will apply also when the camcorder is set to Smart AUTO.

See *Using the Menus* (PDF 31) for details.

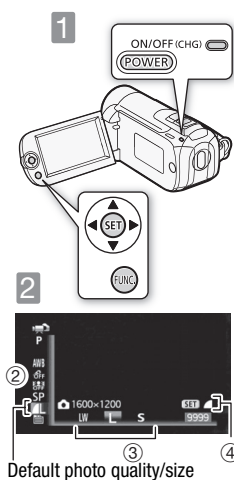

1 Press **POWER**.

2 Select the photo size and quality.

- 1 **FUNC.** >
- 2 [**L** 1600x1200] >
- 3 Desired photo size >
- 4 Press **SET** to select the desired photo quality >
- 5 **FUNC.**

basic playback

Playing Back Movies and Viewing Photos

The basic playback screen is the index screen. Using the tabs at the top of the index screen you can select what recordings to playback (movies or photos) and what memory to play back (built-in memory or memory card, **HFR11/HFR10** only).

See *Playing Back the Video* (PDF 45), *Viewing Photos* (PDF 89) for details.

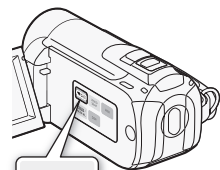

1

- 1 Press to set the camcorder to playback mode.

If a single photo appears, move the zoom lever toward **W**.

- 2 Select the tab of the recordings you wish to play back.

- 1 Select () the tabs at the top of the screen.
- 2 Select () the desired tab.
- 3 Return () to the index screen to select a scene or photo.

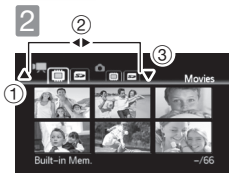

3

- 3 Select (,) the scene or photo you wish to play back.

Move the zoom lever toward **W** to show 15 scenes/photos; move it toward **T** to show 6 scenes/photos.



En

Ft

Es

4 Press **SET** to play back.

Movies: The selected scene is played back. Playback continues until the end of the last scene recorded.

- ① Select (**▲▼**) the **||** (pause) icon and press **SET** to pause the playback. Press again to resume.
- ② Select (**▲▼**) the **■** (stop) icon and press **SET** to stop the playback and return to the index screen.

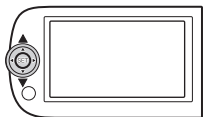

Photos: The selected photo is displayed.

- ① Move (**◀▶**) to the previous/next photo.
- ② Select (**▲▼**) the **■** (index) icon and press **SET** to return to the index screen.

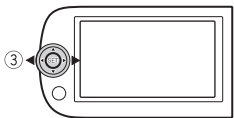

! IMPORTANT

- Observe the following precautions while the ACCESS indicator is on or flashing. Failing to do so may result in permanent data loss or damage to the memory.
 - Do not open the memory card slot cover.
 - Do not disconnect the power source or turn off the camcorder.

- Do not change the operating mode - do not press the  button or **AUTO** button.
- You may not be able to play back with another device the movies you recorded on the memory card with this camcorder. In such case, play back the movies on the memory card using this camcorder.
- You may not be able to play back with this camcorder movies recorded using another device.
- When viewing photos, the following images may not be displayed correctly.
 - Images that were not recorded with this camcorder.
 - Images edited on or uploaded from a computer.
 - Images whose file names have been changed.

NOTES

- When playing back movies, depending on the recording conditions, you may notice brief stops in video or sound playback between scenes.
- The camcorder offers other advanced ways to locate and play back your movies. For example, you can select scenes by recording date (from a list or from a calendar), determine the starting point when playing back long scenes or play back a video clip (complete with background music) made up from video snapshot scenes.

See *Searching for Scenes* ( PDF ) 49) and subsequent pages for details.

- You can also play back a slideshow of your photos (complete with background music).

See *Slideshow* ( PDF ) 93) for details.

Adjusting the Volume







During the playback of a scene, select () the  (volume) icon and adjust () the volume as necessary. To turn the volume off completely, keep the joystick pressed () until the volume bars disappear.

Photo Jump

When you have recorded a large number of photos, you may find it easier to jump 10 or 100 images at a time instead of browsing them one by one. From single photo view:

- ① Select (▲▼) the  (photo jump) icon and press (SET).
- ② Select (▲▼) to jump 10 photos or 100 photos.
- ③ Jump (◀▶) the number of photos selected back/forward.
- ④ Press (SET) to return to single photo view.

Browsing Index Pages



When you have a large number of recordings, you can browse through whole index pages instead of single recordings.

- ① Display (▼) a sidebar below the thumbnails of the scenes/photos.
- ② Move (◀▶) between index pages.

Saving and Sharing Your Recordings

It is recommended that you periodically save your recordings on a computer. Use the supplied software **ImageMixer 3 SE** to save, manage and edit your movies. Use the supplied software **Photo Application** to save, manage and edit your photos.

Video-related software



- See the 'PIXELA Applications' Installation Guide for details about installing the supplied PIXELA applications.
- See the 'ImageMixer 3 SE Software Guide' (PDF file) on the **PIXELA Application - Disc 1** CD-ROM, for details about connecting the camcorder to the computer and saving, managing and editing your movies.
- **HFR11/HFR10** Using the camcorder, you can convert your movies into standard-definition (SD). You can then easily upload these SD videos to your favorite video sharing Web site.
See *Uploading Movies to Video Sharing Web Sites* ( PDF ) 124) for details.

Photo-related software

- See the 'Photo Application' Instruction Manual (PDF file) on the  **Instruction Manual/Photo Applications Ver.34.0/Music Data** CD-ROM, for details about installing the software, connecting the camcorder to the computer and saving, managing and editing your photos.

Saving Recordings without a Computer

If you prefer to save your recordings without having to use a computer, you can use the optional DW-100 DVD Burner to create high-definition or standard definition discs of your movies and Photo DVDs of your photos. You can also connect the camcorder to an external recording device (DVD or HDD recorder, VCR, etc.) to save copies of your movies.

See *Saving Movies onto High-Definition Discs (AVCHD/Blu-ray Discs)* ( PDF ) 113), *Saving Movies onto Standard-Definition Discs (DVD)* ( PDF ) 116), and *Copying Your Recordings to an External Video Recorder* ( PDF ) 123) for details.

Playback on a TV Screen

Connect your camcorder to a TV to enjoy your recordings with family and friends.

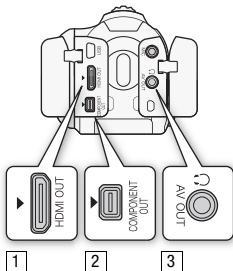

- 1** Turn off the camcorder and the TV.
- 2** Connect the camcorder to the TV.
Select the most appropriate connection according to the input terminals on your TV. In decreasing order of picture quality, the connections are: **1** HDMI, **2** Component video, **3** Composite video.
- 3** Turn on the camcorder.
Press  to turn on the camcorder directly in playback mode.
- 4** Play back your movies or photos as described in the previous pages.

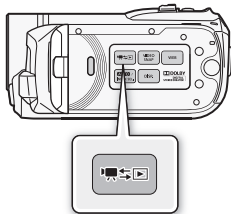

1 HDMI connection: All digital, high-definition connection.

See *About the HDMI™ connection* (PDF 107) for details.

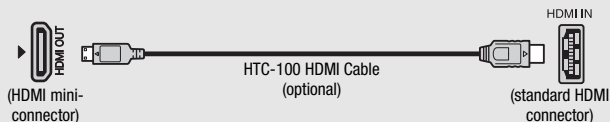

2 Component video connection: Analog, high-definition connection.

See *Connection Diagrams - Connection 2* (PDF 108) for details about additional settings.

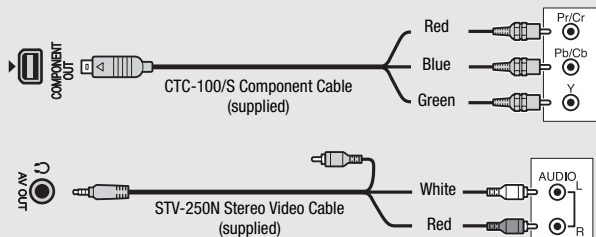

3 Composite video connection: Analog, standard definition connection.

See *Connection Diagrams - Connection 3* (PDF 108) for details about additional settings.

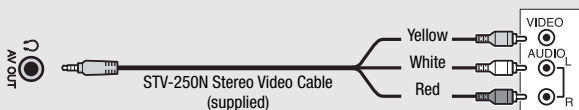

NOTES

- The illustrations are for reference only. The layout of terminals on your TV may be different.
- We recommend powering the camcorder using the compact power adapter.
- Sound from the built-in speaker will be muted while the STV-250N Stereo Cable is connected to the camcorder.
- Adjust the volume using the TV.
- When you play back 16:9 movies on standard TV sets with a 4:3 aspect ratio, the TV set will switch automatically to widescreen mode if it is compatible with the Video ID-1 system. Otherwise, change the aspect ratio of the TV manually.

See *[TV Type]* ( PDF ) 137) for details.

Abridged Specifications

The specifications given here are an **abridged version** of the full specifications of the camcorder. Be sure to read the full version of the instruction manual for the complete information.

See *Specifications* ( PDF) 174 for details.

Recording media

- **HFR11** Built-in flash memory, 32 GB
- **HFR10** Built-in flash memory, 8 GB
- SD or SDHC (SD High Capacity) memory card (not included)

Maximum recording time (approximate figures)

- **HFR11** 32 GB built-in memory:
 - FXP** mode: 4 hr. 10 min. **XP+** mode: 5 hr. 45 min.
 - SP** mode: 9 hr. 35 min. **LP** mode: 12 hr. 15 min.
- **HFR10** 8 GB built-in memory:
 - FXP** mode: 1 hr. **XP+** mode: 1 hr. 25 min.
 - SP** mode: 2 hr. 20 min. **LP** mode: 3 hr.
- Commercially available 16 GB memory card:
 - FXP** mode: 2 hr. 5 min. **XP+** mode: 2 hr. 50 min.
 - SP** mode: 4 hr. 45 min. **LP** mode: 6 hr. 5 min.

Power supply (rated)

7.4 V DC (battery pack), 8.4 V DC (compact power adapter)

Power consumption

2.8 W (SP mode, AF on, LCD normal brightness)

Operating temperature

0 - 40 °C (32 - 104 °F)

Dimensions (W x H x D)

60 x 64 x 124 mm (2.4 x 2.5 x 4.9 in.), excluding the grip belt

Weight

270 g (9.5 oz.) (camcorder body only)

DANGER!

Treat the battery pack with care.

- Keep it away from fire (or it might explode).
- Do not expose the battery pack to temperature higher than 60 °C (140 °F). Do not leave it near a heater or inside a car in hot weather.
- Do not try to disassemble or modify it.
- Do not drop it or subject it to shocks.
- Do not get it wet.

Canon offers a variety of optional accessories for your camcorder.

See *Optional Accessories* ( PDF ) 170 for details.

Use of genuine Canon accessories is recommended.

This product is designed to achieve excellent performance when used with genuine Canon accessories. Canon shall not be liable for any damage to this product and/or accidents such as fire, etc., caused by the malfunction of non-genuine Canon accessories (e.g., a leakage and/or explosion of a battery pack). Please note that this warranty does not apply to repairs arising out of the malfunction of non-genuine Canon accessories, although you may request such repairs on a chargeable basis.

This mark identifies genuine Canon video accessories. When you use Canon video equipment, we recommend Canon-brand accessories or products bearing the same mark.



USA

CANON CONSUMER DIGITAL VIDEO EQUIPMENT LIMITED WARRANTY FOR THE UNITED STATES

The limited warranty set forth below is given by Canon U.S.A., Inc. ("Canon USA") with respect to Canon Consumer Digital Video Equipment (the "Equipment") purchased in the United States. This limited warranty is only effective upon presentation of your Bill of Sale or other proof of purchase.

The Equipment is warranted under normal, non-commercial, personal use, against defective materials or workmanship as follows:

Parts: Defective parts will be exchanged for new parts or comparable rebuilt parts for a period of ONE YEAR from the date of original purchase, except for a defective Video Head, which will be exchanged for a period of three months from the date of purchase.

Labor: For a period of ONE YEAR from the date of original purchase, labor will be provided free of charge by our factory service centers or designated service facilities located in the United States.

When returning Equipment under this warranty, you must pre-pay the shipping charges, and you must enclose the Bill of Sale or other proof of purchase with a complete explanation of the problem. During the ONE-YEAR warranty period, repairs will be made and the Equipment will be return-shipped to you free of charge. For repairs after the warranty period is over, you will be given an estimate of the cost of repair and an opportunity to approve or disapprove of the repair expense before it is incurred. If you approve, repairs will be made and the Equipment will be return-shipped to you. (shipping charges apply). If you disapprove, we will return-ship the equipment at no charge to you.

Non-Canon brand peripheral equipment and software which may be distributed with, or factory loaded on, the Equipment, are sold "AS IS" without warranty of any kind by Canon USA, including any implied warranty regarding merchantability or fitness for a particular purpose. The sole warranty with respect to such non-Canon brand items is given by the manufacturer or producer thereof. If the Equipment contains a hard disk drive, Canon USA recommends that data stored on that drive be duplicated or backed up to prevent its loss in the event of failure or other malfunction of such drive.

Canon USA shall have no responsibility under this limited warranty for use of the Equipment in conjunction with incompatible peripheral equipment and incompatible software.

In order to obtain warranty service, contact the authorized Canon retail dealer from whom you purchased the Equipment or call the CANON INFORMATION CENTER AT 1-800-OK-CANON. You will be directed to the nearest service facility for your Equipment.

This Limited Warranty covers all defects encountered in normal use of the Equipment and does not apply in the following cases:

- A) Loss or damage to the Equipment due to abuse, mishandling, accident, improper maintenance, or failure to follow operating instructions;
- B) If the Equipment is defective as a result of leaking batteries, sand, dirt or water damage;
- C) If defects or damages are caused by the use of unauthorized parts or by service other than by Canon USA's factory service centers or authorized service facilities;
- D) If the Equipment is used for commercial or industrial use.

This Limited Warranty does not cover cabinet (exterior finish), video cassette tape, head cleanings, nor does it apply to Equipment purchased outside the United States. This warranty does not cover units sold to rental firms, military operations, hotels, schools, hospitals or for other commercial, industrial, or institutional applications. These uses are covered only by such specific warranty as Canon may issue with such sales.

This Limited Warranty does not apply to accessories or consumables for the Equipment, which are sold "AS IS", without warranty of any kind by Canon USA.

Please retain this warranty card and your Bill of Sale as a permanent record of your purchase. This card is most important in order to be sure you are contacted right away should there be a safety inspection, modification or product recall under applicable laws or regulations.

NO IMPLIED WARRANTY, INCLUDING MERCHANTABILITY AND FITNESS FOR A PARTICULAR PURPOSE APPLIES TO THIS EQUIPMENT AFTER THE APPLICABLE PERIOD OF EXPRESS WARRANTY OR GUARANTY, EXCEPT AS MENTIONED ABOVE, GIVEN BY ANY PERSON, FIRM OR CORPORATION WITH RESPECT TO THIS EQUIPMENT SHALL BIND THE UNDERSIGNED (SOME STATES DO NOT ALLOW LIMITATIONS ON HOW LONG AN IMPLIED WARRANTY LASTS, SO THE ABOVE LIMITATION OR EXCLUSION MAY NOT APPLY TO YOU). CANON USA SHALL

NOT BE LIABLE FOR LOSS OF REVENUES OR PROFITS, EXPENSE FOR SUBSTITUTE EQUIPMENT OR SERVICE, STORAGE CHARGES, LOSS OR CORRUPTION OF DATA, INCLUDING WITHOUT LIMITATION, LOSS OR CORRUPTION OF DATA STORED ON THE EQUIPMENT'S HARD DRIVE, OR ANY OTHER SPECIAL, INCIDENTAL OR CONSEQUENTIAL DAMAGES CAUSED BY THE USE, MISUSE OR INABILITY TO USE THE EQUIPMENT, REGARDLESS OF THE LEGAL THEORY ON WHICH THE CLAIM IS BASED, AND EVEN IF CANON USA HAS BEEN ADVISED OF THE POSSIBILITY OF SUCH DAMAGES. NOR SHALL RECOVERY OF ANY KIND AGAINST CANON USA BE GREATER THAN THE PURCHASE PRICE OF THE EQUIPMENT SOLD BY CANON USA AND CAUSING THE ALLEGED DAMAGE. WITHOUT LIMITING THE FOREGOING, YOU ASSUME ALL RISK AND LIABILITY FOR LOSS, DAMAGE OR INJURY TO YOU AND YOUR PROPERTY AND TO OTHERS AND THEIR PROPERTY ARISING OUT OF USE, MISUSE OR INABILITY TO USE THE EQUIPMENT NOT CAUSED DIRECTLY BY THE NEGLIGENCE OF CANON USA. (SOME STATES DO NOT ALLOW THE EXCLUSION OR LIMITATION OF INCIDENTAL OR CONSEQUENTIAL DAMAGES, SO THE ABOVE LIMITATION MAY NOT APPLY TO YOU). THIS WARRANTY SHALL NOT EXTEND TO ANYONE OTHER THAN THE ORIGINAL PURCHASER OF THIS EQUIPMENT OR THE PERSON FOR WHOM IT WAS PURCHASED AS A GIFT.

This warranty gives you specific legal rights, and you may also have other rights which vary from state to state.

CANON U.S.A., INC.

CANADA

CANON CONSUMER DIGITAL VIDEO EQUIPMENT LIMITED WARRANTY

The limited warranty set forth below is given by Canon Canada Inc. ("Canon Canada") with respect to Canon Consumer Digital Video Equipment (the "Equipment") purchased in Canada. This limited warranty is only effective upon presentation of a bill of sale or other proof of purchase for this Equipment to a Canon Service Facility when repairs are required.

The Equipment is warranted under normal, non-commercial, personal use, against defective materials or workmanship as follows:

Parts: Defective parts will be exchanged for new parts or, at Canon Canada's option, comparable rebuilt parts for a period of one year from the date of original purchase, except Video Heads which will be exchanged for a period of 3 months from the date of purchase.

Labour: For a period of one year from the date of original purchase, labour will be provided free of charge by our Canon Service Facilities in Canada.

This limited warranty covers all defects except where:

(a) The loss or damage to the product results from:

- i) accident, natural disaster, mishandling, abuse, neglect, unauthorized product modification or failure to follow instructions contained in the instruction manual;
- ii) the use of accessories, attachments, products, supplies, parts or devices with the Equipment that do not conform to Canon specifications or that cause abnormally frequent service problems;
- iii) repairs or services performed by any party other than a Canon Service Facility;
- iv) defective batteries or any exposure to water, sand or dirt;
- v) shipping (claim must be presented to the shipper);

(b) Any serial number on the video equipment is altered or removed.

(c) The Equipment is used for commercial, professional or industrial purposes.

This limited warranty does not cover the cabinet (exterior finish) of the Equipment, media, nor does it apply to Equipment purchased outside Canada.

If the Equipment contains a hard disk drive, Canon Canada recommends that data stored on that drive be duplicated or backed up to prevent its loss in the event of a failure or other malfunction of such drive.

TO OBTAIN WARRANTY SERVICE

Ship your Equipment in its original carton, box or equivalent, properly packed, fully insured with shipping charges prepaid, together with a copy of your bill of sale or other proof of purchase and a description of the problem to any of the Canon Service Facilities in Canada.

LIMITATIONS

Except as otherwise required by applicable legislation, this warranty is in lieu of all other warranties, conditions, guarantees or representations, express or implied, statutory or otherwise, relative to the Equipment, including implied warranties or conditions of merchantability or fitness for a particular purpose.

Canon Canada assumes no liability for special, consequential or incidental damages, loss or corruption of data including, without limitation, data stored on the hard disk drive of the Equipment or loss that may arise, whether on account of negligence or otherwise, from the use, misuse or inability to use the Equipment (including loss of profit, revenue, media or enjoyment) or from failure to conform to any express or implied warranties, conditions, guarantees or representations. Any recovery under this limited warranty shall not exceed the purchase price of the equipment. Canon Canada does not assume or authorize any other person to assume for Canon Canada any other liability with respect to this equipment.

This warranty does not extend to any person other than the original purchaser of the Equipment or the person for whom it was purchased as a gift and states your exclusive remedy.

NOTICE TO CONSUMER

If you plan to take important videos or if the product has not been used for some time, please check all functions with the instruction book before using it.



USA	CANON U.S.A., INC. NEW JERSEY OFFICE 100 Jamesburg Road, Jamesburg, NJ 08831 USA CANON U.S.A., INC. CHICAGO OFFICE 100 Park Blvd., Itasca, IL 60143 USA CANON U.S.A., INC. LOS ANGELES OFFICE 15955 Alton Parkway, Irvine, CA 92618 USA CANON U.S.A., INC. HONOLULU OFFICE 210 Ward Avenue, Suite 200, Honolulu, HI 96814 USA
	❖ If you have any questions, call the Canon U.S.A. Information Center toll-free at 1-800-828-4040 (USA only).

CANADA	CANON CANADA INC. 6390 Dixie Road, Mississauga, ON L5T 1P7 CANON CANADA INC. CALGARY 2828 16th Street NE, Calgary, AB T2E 7K7 CANON CANADA INC. MONTREAL 8801 Route Transcanadienne, Saint-Laurent, QC H4S 1Z6
	❖ If you have any questions, call the Canon Canada Information Center toll free (in Canada only) at 1-800-OK-CANON (1-800-652-2666).
	❖ Si vous avez des questions, veuillez téléphoner 1-800-OK-CANON (1-800-652-2666, sans frais au Canada seulement).

MÉXICO	CANON MEXICANA, S DE RL DE CV Blvd. Manuel Ávila Camacho No. 138, Piso 17 Col. Lomas de Chapultepec, C.P. 11000 México, D.F., México CANON U.S.A., INC. NEW JERSEY OFFICE 100 Jamesburg Road, Jamesburg, NJ 08831 USA
---------------	---

CENTRO Y SURAMÉRICA	CANON LATIN AMERICA, INC. 703 Waterford Way, Suite 400, Miami, FL 33126 USA
----------------------------	---

ASIA	CANON HONGKONG COMPANY LTD. 19/F, The Metropolis Tower, 10 Metropolis Drive, Hungghom, Kowloon, Hong Kong Tel: +852 3191 2333, Fax: +852 2428 3963
-------------	--

- For support concerning the supplied PIXELA applications, please call PIXELA customer support (details in the 'PIXELA Applications' Installation Guide).
- Pour le support technique concernant les logiciels PIXELA fournis, veuillez appeler le service clientèle de PIXELA (les détails se trouvent dans le Guide d'installation 'PIXELA Applications').
- Para soporte relacionado las aplicaciones de PIXELA suministradas, llame al centro de atención al cliente de PIXELA (vea los detalles en la Guía de instalación 'PIXELA Applications').